

MOD:XEBC-06EU-EPRM



ENGLISH

TECHNICAL DATA

- 01 POWER
- 03 FREQUENCY
- 04 POWER SUPPLY CABLE TYPE
- 05 EXTERNAL Ø OF POWER SUPPLY CABLE
- 06 VOLTAGE / POWER CABLE SECTION / CURRENT

14 kW
50 / 60 Hz
H07RN-F
16 mm

380-415 V~3PH+N+PE
5G x 2,5 mm²
Circuit Breaker 25 A
I1=20 A - I2=20 A - I3=22 A - In=2 A

220-240 V~3PH+PE
4G x 6 mm²
Circuit Breaker 40 A
I1=36 A - I2=36 A - I3=36 A - In=

220-240 V~1PH+PE (Kit required)
3G x 10 mm²
Circuit Breaker 63 A
I1=61.5 A - I2= - I3= - In=61.5 A

- 10 WATER PRESSURE
- 11 MAX FOOD LOAD
- 13 WATER MAX CONSUMPTION
- 02 NOMINAL HEAT INPUT
- 18 CAVITY DIMENSIONS (W - D - H)
- 20 IP PROTECTION CLASS

150-600 kPa / 21-87 psi kPa
30 kg
9,8 l/h @ 200 kPa
13,5 kW
716x561x560 mm
X4

ITALIANO

- 01 POTENZA
- 03 FREQUENZA
- 04 TIPO DI CAVO ALIMENTAZIONE
- 05 Ø ESTERNO CAVO DI ALIMENTAZIONE
- 06 TENSIONE / SEZIONE CAVI ALIMENTAZIONE / CORRENTE
- 10 PRESSIONE ACQUA
- 11 CARICA MAX CIBO
- 13 CONSUMO MAX ACQUA
- 02 POTENZA TERMICA NOMINALE
- 18 DIMENSIONI CAMERA COTTURA (L - P - H)
- 20 GRADO PROTEZIONE IP

FRANCAIS

- 01 PUISSANCE ELECTRIQUE
- 03 FREQUENCE
- 04 TYPE DE CABLE D'ALIMENTATION
- 05 Ø EXTERNE DU CABLE D'ALIMENTATION
- 06 TENSION / SECTION CABLE D'ALIM.
- 10 PRESSION DE L'EAU
- 11 CHARGE MAXIMALE D'ALIMENT
- 13 CONSOMMATION MAX DE L'EAU
- 02 DEBIT THERMIQUE NOMINAL
- 18 DIMENSIONS CHAMBRE DE COUSSION (L - P - A)
- 20 INDICE DE PROTECTION IP

ESPAÑOL

- 01 POTENCIA
- 03 FRECUENCIA
- 04 TIPO DE CABLE DE ALIMENTACION
- 05 Ø CABLE EXTERNO DE ALIMENTACION
- 06 TENSION / SECCION CABLES DE ALIMENTACION
- 10 PRESION AGUA
- 11 CARGA MAX. DE ALIMENTOS
- 13 CONSUMO MAX DE AGUA
- 02 POTENCIA TERMICA NOMINAL
- 18 DIMENSIONES CÁMARA DE COCCIÓN (An - Pr - Al)
- 20 GRADO DE PROTECCION IP

DEUTSCH

- 01 ELEKTRISCHE LEISTUNG
- 03 FREQUENZ
- 04 ZULEITUNGSKABELTYP
- 05 AUSSENDURCHMESSER DES VERSORGUNGSKABELS
- 06 KABELQUERSCHNITT UND VERSORGUNGSSPANNUNG
- 10 WASSERDRUCK
- 11 MAX. SPEISENFASSUNGSVERMOGEN
- 13 MAXIMUM WASSERVERBRAUCH
- 02 NOMINALE WARMELEISTUNG
- 18 GRÖÖE DES KOCHKAMMERS (B - T - H)
- 20 SCHTZART IP



MOD:XEBC-06EU-EPRM



ENGLISH - DRAWINGS

2	TERMINAL BOARD POWER SUPPLY
3	UNIPOTENTIAL TERMINAL
6	TECHNICAL DATA PLATE
7	SAFETY THERMOSTAT
8	3/4" THREAD WATER INLET
10	Rotor.KLEAN CONNECTION
11	CAVITY DRAIN PIPE
12	HOT FUMES EXHAUST CHIMNEY
13	ACCESSORIES CONNECTION
27	COOLING AIR OUTLET

ITALIANO - DISEGNI

2	MORSETTIERA ALIMENTAZIONE
3	MORSETTO EQUIPOTENZIALE
6	TARGHETTA DATI TECNICI
7	TERMOSTATO DI SICUREZZA
8	INGRESSO ACQUA 3/4"
10	INGRESSO Rotor.KLEAN
11	SCARICO CAMERA DI COTTURA
12	USCITA FUMI CALDI
13	COLLEGAMENTO ACCESSORI
27	USCITA ARIA DI RAFFREDDAMENTO

FRANCAIS - ENCOMBREMEN

2	BOITE A BORNES D'ALIMENTATION
3	SUPPORT BORNE EQUIPOTENTIELLE
6	PLAQUETTE SEGNALETTIQUE
7	THERMOSTAT DE SECURITE
8	ARRIVE D'EAU FIELT 3/4"
10	ENTREE Rotor.KLEAN
11	SORTIE DE L'EAU RACCORD
12	SORTIE DES FUMES CHAUDES
13	JONCTION DES ACCESSOIRES
27	SORTIE D'EAU DE REFROIDISSEMENT

ESPAÑOL - DISEÑOS

2	CAJA DE CONEXION
3	SEDE BORNE EQUIPOTENCIAL
6	TARJETA DE CARACTERISTICAS TECNICAS
7	TERMOSTATO DE SEGURIDAD
8	ENTRADA DE AGUA 3/4"
10	INGRESO Rotor.KLEAN
11	DESCARGA CAMARA DE COCCION
12	SALIDA HUMOS CALIENTES
13	CONEXION ACCESORIOS
27	SALIDA DEL AIRE DE ENFRIAMIENTO

DEUTSCH - ZEICHNUNGEN

2	ZULEITUNGSKLEMMLEISTE
3	GLEICHPOTENTIELLE KLAMMER
6	TYPENSCHILD
7	SICHERHEITSTHERMOSTAT
8	WASSEREINZUG 3/4" GEWINDE
10	Rotor.KLEAN EINGANG
11	WASSERAUSLASS GEWINDE
12	ABZUGSHAUBE
13	ZUBEHÖRTEILENVERBINDUNG
27	KÜHLLUFTAUSRITT

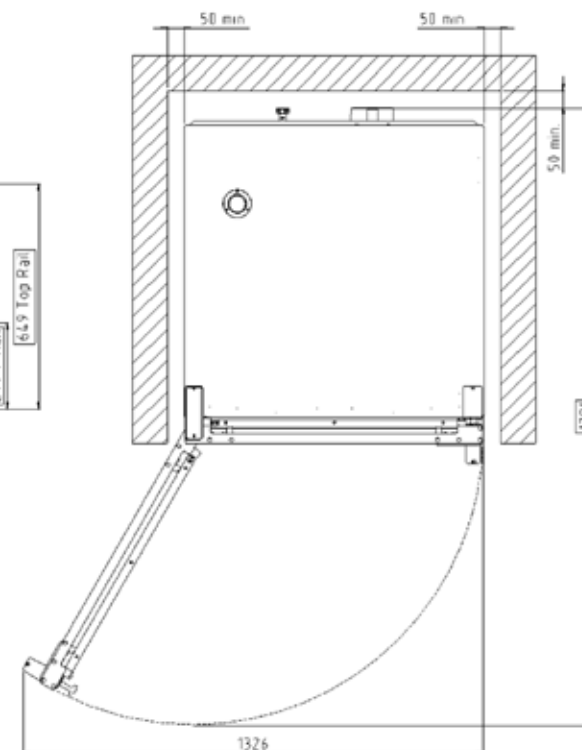
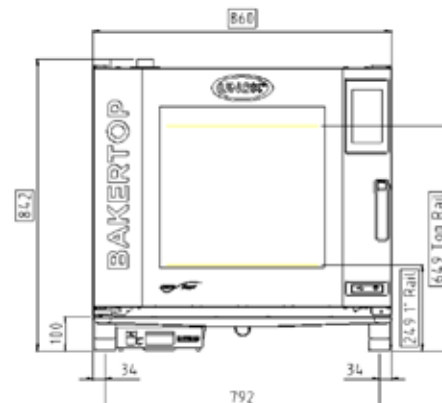
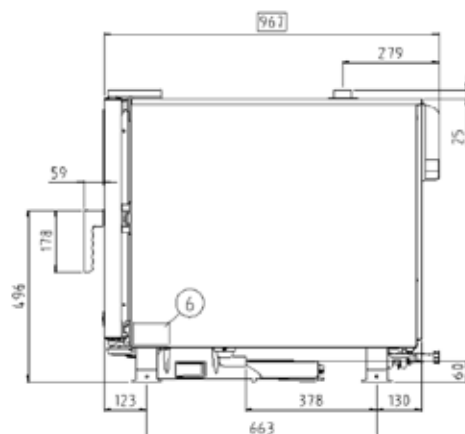
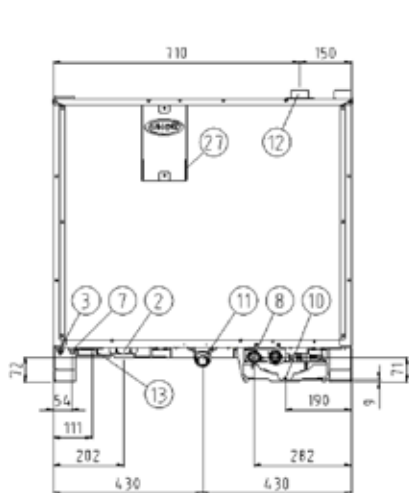

MOD:XEBC-06EU-EPRM

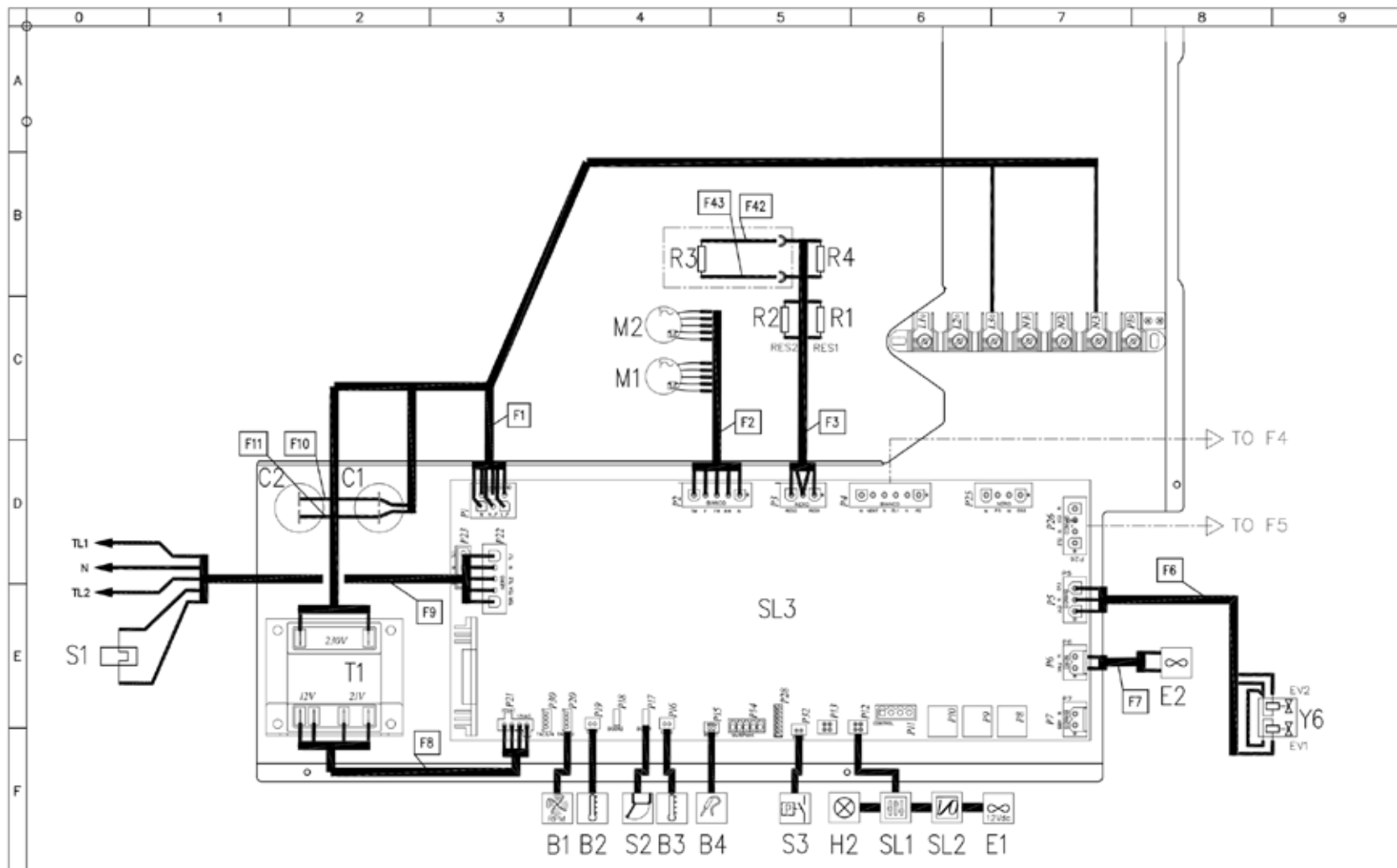

MOD:XEBC-06EU-EPRM

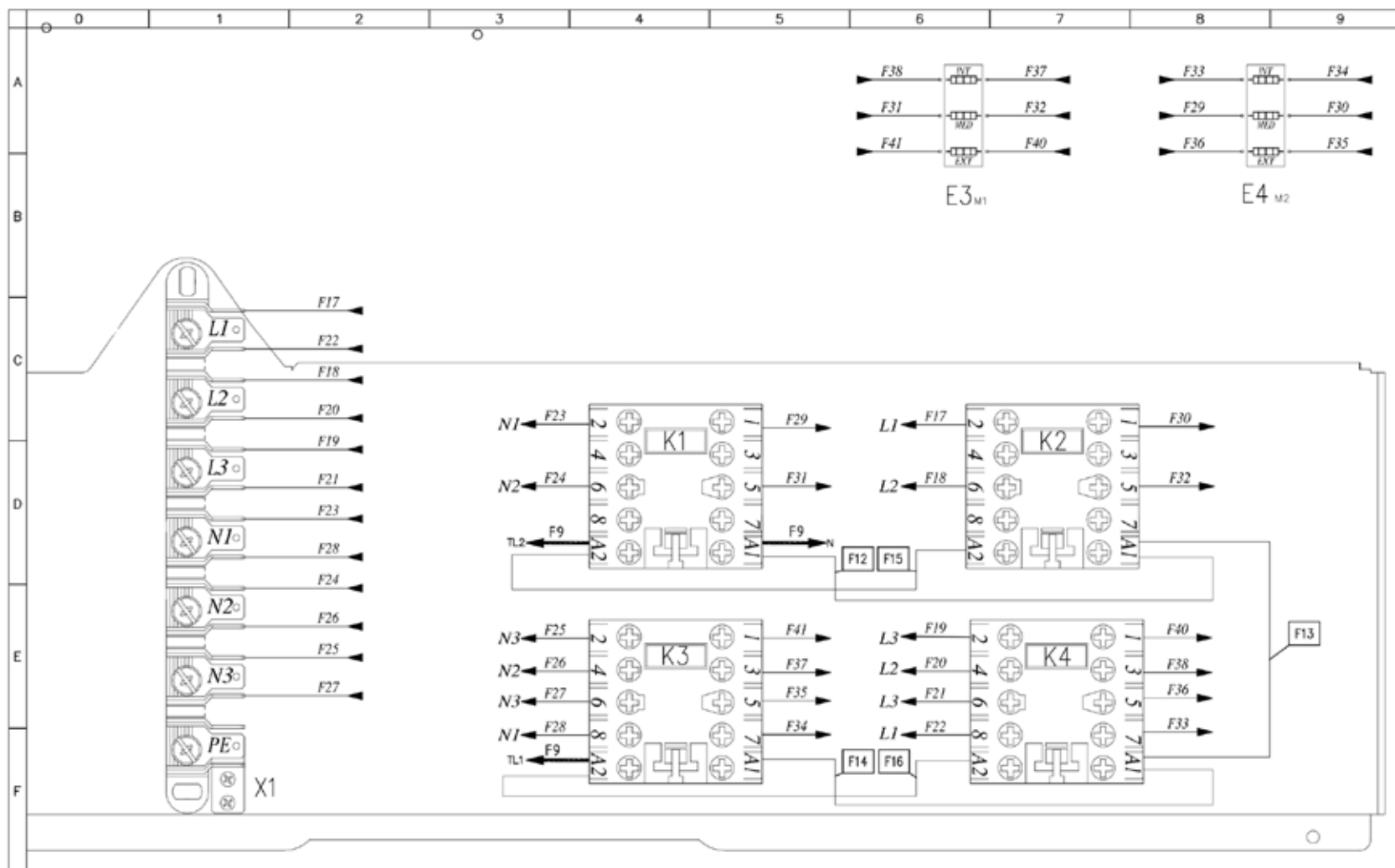

MOD:XEBC-06EU-EPRM

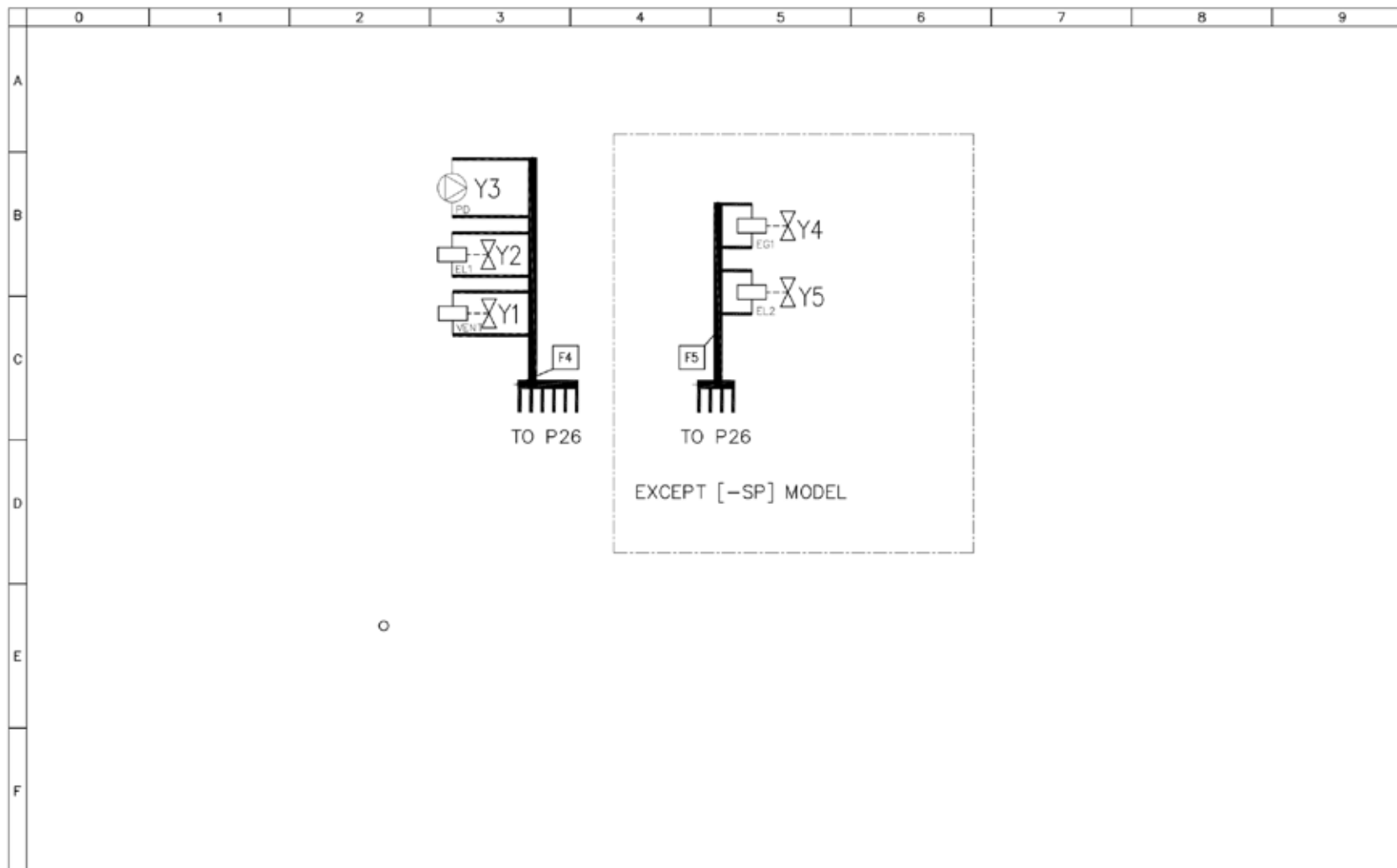

MOD:XEBC-06EU-EPRM



	0	1	2	3	4	5	6	7	8	9																																																																																																																																																
A																																																																																																																																																										
B																																																																																																																																																										
C																																																																																																																																																										
D																																																																																																																																																										
E																																																																																																																																																										
F																																																																																																																																																										
	0	1	2	3	4	5	6	7	8	9																																																																																																																																																
	<table border="1"> <thead> <tr> <th>Sigle</th> <th>ITALIANO</th> <th>ENGLISH</th> <th>FRANCAIS</th> <th>ESPAÑOL</th> <th>DEUTSCH</th> </tr> </thead> <tbody> <tr> <td>C1,C2</td> <td>CONDENSATORE</td> <td>MOTOR CAPACITOR</td> <td>CONDENSATEUR</td> <td>CONDENSADOR</td> <td>KONDENSATOR</td> </tr> <tr> <td>K1,K2,K3,K4</td> <td>TELERUTTORE</td> <td>CONTACTOR</td> <td>TELERUPTEUR</td> <td>TELERRUPTOR</td> <td>RELAIS</td> </tr> <tr> <td>SL3</td> <td>SCHEDA POTENZA</td> <td>POWER CARD</td> <td>CARTE DE PUISSANCE</td> <td>TARJETA POTENCIA</td> <td>POWERPLATINE</td> </tr> <tr> <td>T1</td> <td>TRASFORMATORE</td> <td>TRANSFORMER</td> <td>TRASFORMATEUR</td> <td>TRANSFORMADOR</td> <td>TRANSFORMATOR</td> </tr> <tr> <td>X1</td> <td>MORSETTIERA 7P</td> <td>TERMINAL BLOCK 7P</td> <td>BORNIER 7P</td> <td>CONECTOR 7P</td> <td>KLEMMLEISTE 7P</td> </tr> <tr> <td>Y1</td> <td>DRY MAXY</td> <td>DRY MAXY</td> <td>DRY MAXY</td> <td>DRY MAXY</td> <td>DRY MAXY</td> </tr> <tr> <td>Y2,Y4,Y5</td> <td>ELETTROVALVOLA ACQUA</td> <td>WATER SOLENOID VALVE</td> <td>ELECTROVANNE EAU</td> <td>ELETTROVALVULA</td> <td>ELEKTROVENTIL</td> </tr> <tr> <td>Y3</td> <td>POMPA</td> <td>PUMP</td> <td>POMPE</td> <td>BOMBA</td> <td>PUMPE</td> </tr> <tr> <td>B1</td> <td>SENSORE VELOCITA MOTORE</td> <td>MOTOR SPEED SENSOR</td> <td>CAPTEUR DE VITESSE MOTEUR</td> <td>SENSOR DE VELOCIDAD MOTOR</td> <td>GESCHWINDIGKEITSSENSOR</td> </tr> <tr> <td>B2,B3</td> <td>SONDA CAMERA</td> <td>TEMPERATURE PROBE</td> <td>SONDE DE CHAMBRE</td> <td>SONDA CAMARA</td> <td>GARRAUMTEMPERATURFUHLER</td> </tr> <tr> <td>B4</td> <td>SONDA AL CUORE</td> <td>CORE PROBE</td> <td>SONDE A COEUR</td> <td>SONDA CORAZON</td> <td>KERNTEMPERATURFUHLER</td> </tr> <tr> <td>E1</td> <td>VENTOLA RAFFREDDAMENTO 12V</td> <td>COOLING FAN 12V</td> <td>TURBINE DE REFROIDISSEMENT 12V</td> <td>TURBINA DE REFRIGERACION 12V</td> <td>LÜFTER 12V</td> </tr> <tr> <td>E2</td> <td>VENTOLA RAFFREDDAMENTO 230V</td> <td>COOLING FAN 230V</td> <td>TURBINE DE REFROIDISSEMENT 230V</td> <td>TURBINA DE REFRIGERACION 230V</td> <td>LÜFTER 230V</td> </tr> <tr> <td>E3,E4</td> <td>ELEMENTO RISCALDANTE</td> <td>HEATING ELEMENT</td> <td>ELEMENT DE CHAUFFAGE</td> <td>RESISTENCIA DE CALEFACCIÓN</td> <td>HEIZUNG</td> </tr> <tr> <td>H2</td> <td>LUCE CAMERA</td> <td>OVEN LIGHT</td> <td>ECLAIRAGE DE CHAMBRE</td> <td>LUZ CAMARA</td> <td>BELEUCHTUNG</td> </tr> <tr> <td>M1,M2</td> <td>MOTORE</td> <td>MOTOR</td> <td>MOTEUR</td> <td>MOTOR</td> <td>MOTOR</td> </tr> <tr> <td>R1,R2,R3,R4</td> <td>RESISTENZA DI MODULAZIONE VENTILATORE</td> <td>MOTOR MODULATION RESISTANCE</td> <td>RESISTANCE DE MODULATION VENTILATEUR</td> <td>RESISTENCIA MODULACION VELOCIDAD</td> <td>WIDERSTAND LOW FAN</td> </tr> <tr> <td>S1</td> <td>TERMOSTATO SICUREZZA</td> <td>SAFETY THERMOSTAT</td> <td>THERMOSTAT DE SECURITE</td> <td>TERMOSTATO DE SEGURIDAD</td> <td>SICHERHEITS THERMOSTAT</td> </tr> <tr> <td>S2</td> <td>MICRO INTERRUTTORE PORTA</td> <td>DOOR MICROSWITCH</td> <td>MICROINTERRUPTEUR DE PORTE</td> <td>MICROINTERRUPTOR PUERTA</td> <td>TURKONTAKTSCHALTER</td> </tr> <tr> <td>S3</td> <td>PRESSOSTATO</td> <td>PRESSURE SWITCH</td> <td>PRESSOSTAT</td> <td>PRESÓSTATO</td> <td>DRUCKSCHALTER</td> </tr> <tr> <td>SL1</td> <td>SCHEDA CONTROLLO</td> <td>CONTROL BOARD</td> <td>CARTE DE CONTROLE</td> <td>TARJETA DE CONTROL</td> <td>KONTROLL PLATINE</td> </tr> <tr> <td>SL2</td> <td>SCHEDA 1/0 - USB</td> <td>USB - 1/0 BOARD</td> <td>USB - CARTE 1/0</td> <td>USB - TARJETA 1/0</td> <td>USB - 1/0 PLATINE</td> </tr> <tr> <td>Y6</td> <td>ELETTROVALVOLA ACQUA 3 STADI</td> <td>WATER SOLENOID VALVE 3STAGE</td> <td>ELECTROVANNE EAU 3 ETAPES</td> <td>ELETTROVALVULA 3 ETAPAS</td> <td>ELEKTROVENTIL 3 STUFEN</td> </tr> </tbody> </table>										Sigle	ITALIANO	ENGLISH	FRANCAIS	ESPAÑOL	DEUTSCH	C1,C2	CONDENSATORE	MOTOR CAPACITOR	CONDENSATEUR	CONDENSADOR	KONDENSATOR	K1,K2,K3,K4	TELERUTTORE	CONTACTOR	TELERUPTEUR	TELERRUPTOR	RELAIS	SL3	SCHEDA POTENZA	POWER CARD	CARTE DE PUISSANCE	TARJETA POTENCIA	POWERPLATINE	T1	TRASFORMATORE	TRANSFORMER	TRASFORMATEUR	TRANSFORMADOR	TRANSFORMATOR	X1	MORSETTIERA 7P	TERMINAL BLOCK 7P	BORNIER 7P	CONECTOR 7P	KLEMMLEISTE 7P	Y1	DRY MAXY	DRY MAXY	DRY MAXY	DRY MAXY	DRY MAXY	Y2,Y4,Y5	ELETTROVALVOLA ACQUA	WATER SOLENOID VALVE	ELECTROVANNE EAU	ELETTROVALVULA	ELEKTROVENTIL	Y3	POMPA	PUMP	POMPE	BOMBA	PUMPE	B1	SENSORE VELOCITA MOTORE	MOTOR SPEED SENSOR	CAPTEUR DE VITESSE MOTEUR	SENSOR DE VELOCIDAD MOTOR	GESCHWINDIGKEITSSENSOR	B2,B3	SONDA CAMERA	TEMPERATURE PROBE	SONDE DE CHAMBRE	SONDA CAMARA	GARRAUMTEMPERATURFUHLER	B4	SONDA AL CUORE	CORE PROBE	SONDE A COEUR	SONDA CORAZON	KERNTEMPERATURFUHLER	E1	VENTOLA RAFFREDDAMENTO 12V	COOLING FAN 12V	TURBINE DE REFROIDISSEMENT 12V	TURBINA DE REFRIGERACION 12V	LÜFTER 12V	E2	VENTOLA RAFFREDDAMENTO 230V	COOLING FAN 230V	TURBINE DE REFROIDISSEMENT 230V	TURBINA DE REFRIGERACION 230V	LÜFTER 230V	E3,E4	ELEMENTO RISCALDANTE	HEATING ELEMENT	ELEMENT DE CHAUFFAGE	RESISTENCIA DE CALEFACCIÓN	HEIZUNG	H2	LUCE CAMERA	OVEN LIGHT	ECLAIRAGE DE CHAMBRE	LUZ CAMARA	BELEUCHTUNG	M1,M2	MOTORE	MOTOR	MOTEUR	MOTOR	MOTOR	R1,R2,R3,R4	RESISTENZA DI MODULAZIONE VENTILATORE	MOTOR MODULATION RESISTANCE	RESISTANCE DE MODULATION VENTILATEUR	RESISTENCIA MODULACION VELOCIDAD	WIDERSTAND LOW FAN	S1	TERMOSTATO SICUREZZA	SAFETY THERMOSTAT	THERMOSTAT DE SECURITE	TERMOSTATO DE SEGURIDAD	SICHERHEITS THERMOSTAT	S2	MICRO INTERRUTTORE PORTA	DOOR MICROSWITCH	MICROINTERRUPTEUR DE PORTE	MICROINTERRUPTOR PUERTA	TURKONTAKTSCHALTER	S3	PRESSOSTATO	PRESSURE SWITCH	PRESSOSTAT	PRESÓSTATO	DRUCKSCHALTER	SL1	SCHEDA CONTROLLO	CONTROL BOARD	CARTE DE CONTROLE	TARJETA DE CONTROL	KONTROLL PLATINE	SL2	SCHEDA 1/0 - USB	USB - 1/0 BOARD	USB - CARTE 1/0	USB - TARJETA 1/0	USB - 1/0 PLATINE	Y6	ELETTROVALVOLA ACQUA 3 STADI	WATER SOLENOID VALVE 3STAGE	ELECTROVANNE EAU 3 ETAPES	ELETTROVALVULA 3 ETAPAS	ELEKTROVENTIL 3 STUFEN
Sigle	ITALIANO	ENGLISH	FRANCAIS	ESPAÑOL	DEUTSCH																																																																																																																																																					
C1,C2	CONDENSATORE	MOTOR CAPACITOR	CONDENSATEUR	CONDENSADOR	KONDENSATOR																																																																																																																																																					
K1,K2,K3,K4	TELERUTTORE	CONTACTOR	TELERUPTEUR	TELERRUPTOR	RELAIS																																																																																																																																																					
SL3	SCHEDA POTENZA	POWER CARD	CARTE DE PUISSANCE	TARJETA POTENCIA	POWERPLATINE																																																																																																																																																					
T1	TRASFORMATORE	TRANSFORMER	TRASFORMATEUR	TRANSFORMADOR	TRANSFORMATOR																																																																																																																																																					
X1	MORSETTIERA 7P	TERMINAL BLOCK 7P	BORNIER 7P	CONECTOR 7P	KLEMMLEISTE 7P																																																																																																																																																					
Y1	DRY MAXY	DRY MAXY	DRY MAXY	DRY MAXY	DRY MAXY																																																																																																																																																					
Y2,Y4,Y5	ELETTROVALVOLA ACQUA	WATER SOLENOID VALVE	ELECTROVANNE EAU	ELETTROVALVULA	ELEKTROVENTIL																																																																																																																																																					
Y3	POMPA	PUMP	POMPE	BOMBA	PUMPE																																																																																																																																																					
B1	SENSORE VELOCITA MOTORE	MOTOR SPEED SENSOR	CAPTEUR DE VITESSE MOTEUR	SENSOR DE VELOCIDAD MOTOR	GESCHWINDIGKEITSSENSOR																																																																																																																																																					
B2,B3	SONDA CAMERA	TEMPERATURE PROBE	SONDE DE CHAMBRE	SONDA CAMARA	GARRAUMTEMPERATURFUHLER																																																																																																																																																					
B4	SONDA AL CUORE	CORE PROBE	SONDE A COEUR	SONDA CORAZON	KERNTEMPERATURFUHLER																																																																																																																																																					
E1	VENTOLA RAFFREDDAMENTO 12V	COOLING FAN 12V	TURBINE DE REFROIDISSEMENT 12V	TURBINA DE REFRIGERACION 12V	LÜFTER 12V																																																																																																																																																					
E2	VENTOLA RAFFREDDAMENTO 230V	COOLING FAN 230V	TURBINE DE REFROIDISSEMENT 230V	TURBINA DE REFRIGERACION 230V	LÜFTER 230V																																																																																																																																																					
E3,E4	ELEMENTO RISCALDANTE	HEATING ELEMENT	ELEMENT DE CHAUFFAGE	RESISTENCIA DE CALEFACCIÓN	HEIZUNG																																																																																																																																																					
H2	LUCE CAMERA	OVEN LIGHT	ECLAIRAGE DE CHAMBRE	LUZ CAMARA	BELEUCHTUNG																																																																																																																																																					
M1,M2	MOTORE	MOTOR	MOTEUR	MOTOR	MOTOR																																																																																																																																																					
R1,R2,R3,R4	RESISTENZA DI MODULAZIONE VENTILATORE	MOTOR MODULATION RESISTANCE	RESISTANCE DE MODULATION VENTILATEUR	RESISTENCIA MODULACION VELOCIDAD	WIDERSTAND LOW FAN																																																																																																																																																					
S1	TERMOSTATO SICUREZZA	SAFETY THERMOSTAT	THERMOSTAT DE SECURITE	TERMOSTATO DE SEGURIDAD	SICHERHEITS THERMOSTAT																																																																																																																																																					
S2	MICRO INTERRUTTORE PORTA	DOOR MICROSWITCH	MICROINTERRUPTEUR DE PORTE	MICROINTERRUPTOR PUERTA	TURKONTAKTSCHALTER																																																																																																																																																					
S3	PRESSOSTATO	PRESSURE SWITCH	PRESSOSTAT	PRESÓSTATO	DRUCKSCHALTER																																																																																																																																																					
SL1	SCHEDA CONTROLLO	CONTROL BOARD	CARTE DE CONTROLE	TARJETA DE CONTROL	KONTROLL PLATINE																																																																																																																																																					
SL2	SCHEDA 1/0 - USB	USB - 1/0 BOARD	USB - CARTE 1/0	USB - TARJETA 1/0	USB - 1/0 PLATINE																																																																																																																																																					
Y6	ELETTROVALVOLA ACQUA 3 STADI	WATER SOLENOID VALVE 3STAGE	ELECTROVANNE EAU 3 ETAPES	ELETTROVALVULA 3 ETAPAS	ELEKTROVENTIL 3 STUFEN																																																																																																																																																					

MOD:XEBC-06EU-EPRM



ED1408A POWER SUPPLY - CONNECTION DIAGRAM

380-415V ~ 3PH + N + PE 50/60Hz

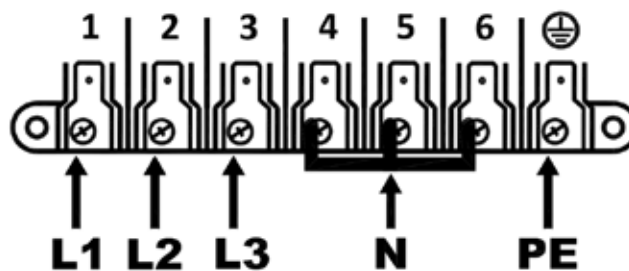

220-240V ~ 3PH + PE 50/60Hz

