

*208.040 **TRITURATOR** - MANUAL

MOULIN N°10

INSTRUCTIONS

DISMANTLING

Casing:

Press slightly on one of the two fastening lugs and release from side of hopper

Hopper and Cross-piece:

Press on the two holding springs, in order to have the clips drop down by themselves.

Shaft:

Pull it out by rotating it clockwise, in order to keep clear of the stopping blade.

Sieve:

Seize it in both hands by the outer side and unfasten anticlockwise with a dead blow.

NOTE

When the machine is new, the inside of the sieve is rough, in order to make the L.T. TRITURATOR effective.

On the contrary, when the inside of the sieve is becoming smooth, it must be replaced.



P10006
handle

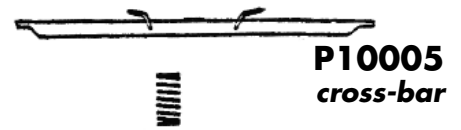

P10005
cross-bar

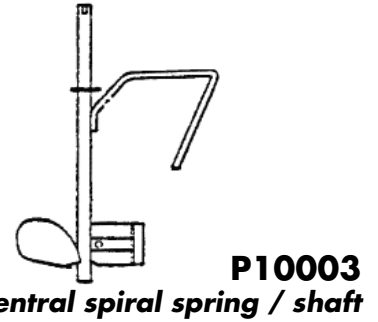

P10003
central spiral spring / shaft

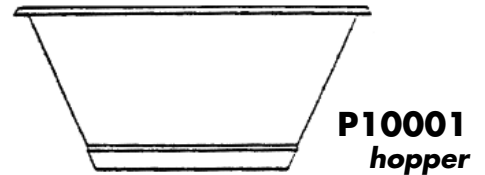

P10001
hopper

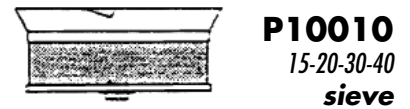

P10010
15-20-30-40
sieve



P10004
anti-splash cylinder

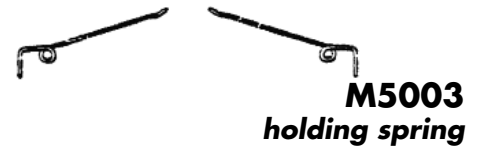

M5003
holding spring

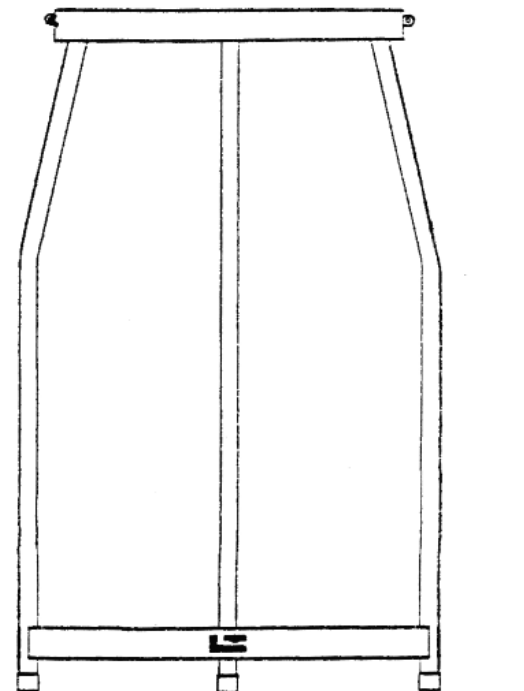

P10007
tripod with holding spring

full-sized sieve perforations

1 mm

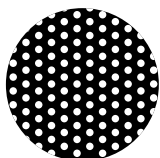

1,5 mm

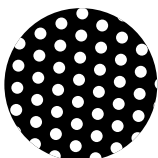

2 mm

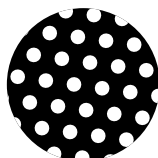

3 mm

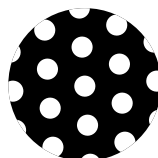

4 mm

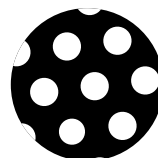

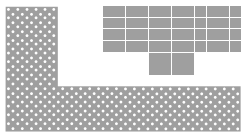

*208.040 **MOULIN** - MANUAL

MOULIN N°10

INSTRUCTIONS

DEMONTAGE

Carter:

appuyer légèrement sur l'une des trois pattes de serrage en tirant vers soi

Cône et Traverse :

appuyer sur les deux ressorts de fixation: les étriers tombent d'eux-mêmes.

Arbre:

Le sortir en le tournant dans le sens de rotation afin d'éviter la palette d'arrêt.

Grille:

la prendre à deux mains par l'extérieur et desserrer «d'un coup sec» dans le sens contraire au mouvement.

REMARQUE

Lorsque l'appareil est neuf, l'intérieur de la grille est très rugueux, ce qui est un facteur d'efficacité du MOULIN L.T. Aussi, il est bien évident que lorsque l'intérieur de la grille devient lisse, il est alors nécessaire de la remplacer.

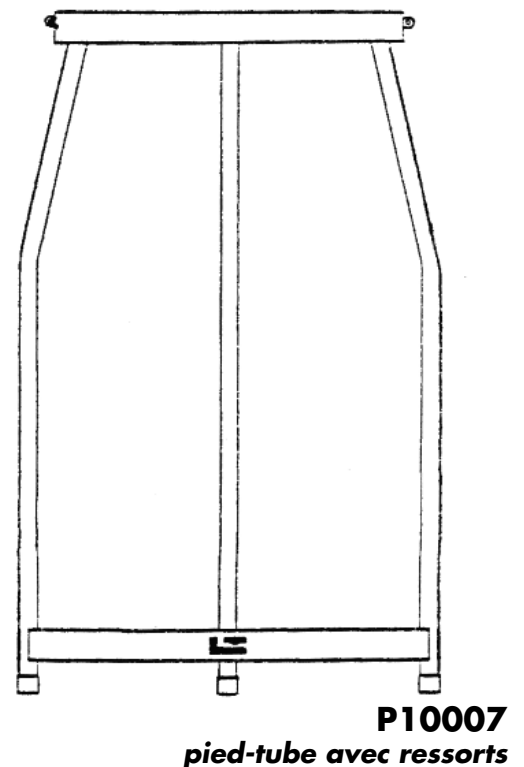
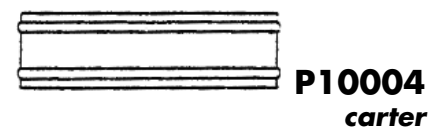
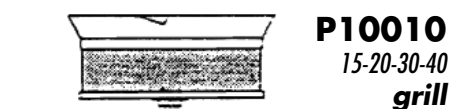
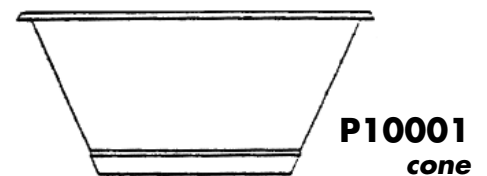
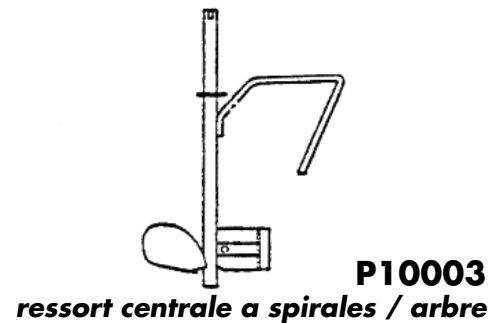
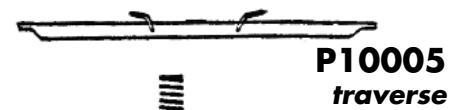

perforations, grandeur nature, de grilles

1 mm

1,5 mm

2 mm

3 mm

4 mm

